

I-GUIDE

GUARDLITE POST AND HOLDER

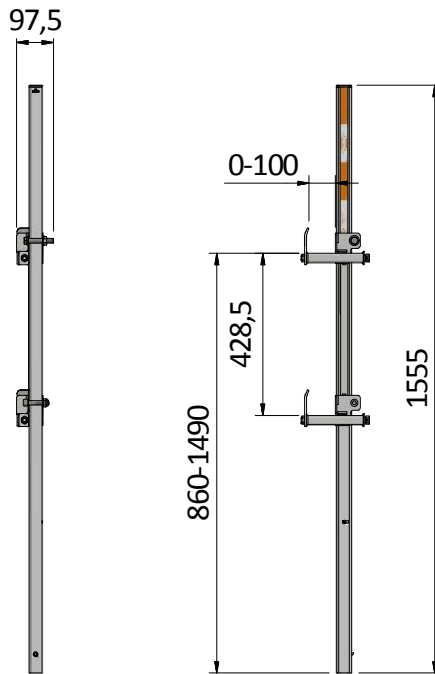
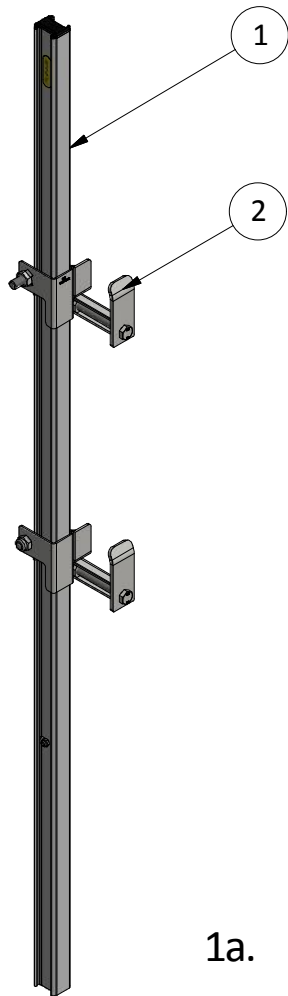
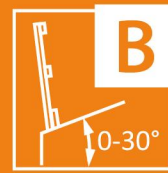

Art nr 9-720-02-021
Galvanized (Holder)
4,0 kg
EN 13374-A-B-C
Max c/c 2,4 or 1,2 m

[mm]

ITEM	QTY	ART. NO
1	1	9-720-02-002
2	1	9-720-02-007

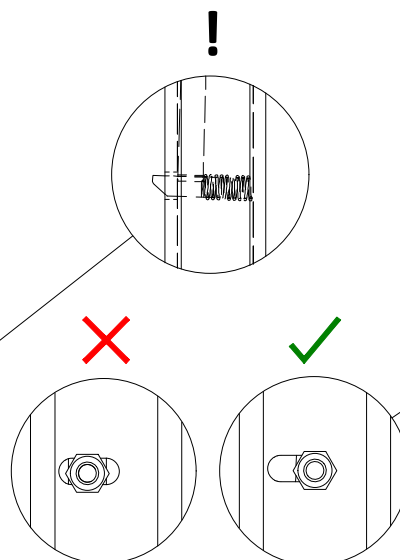
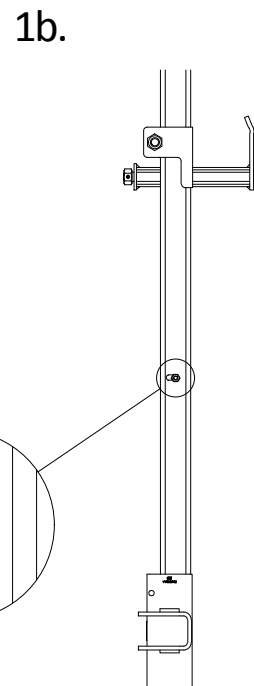
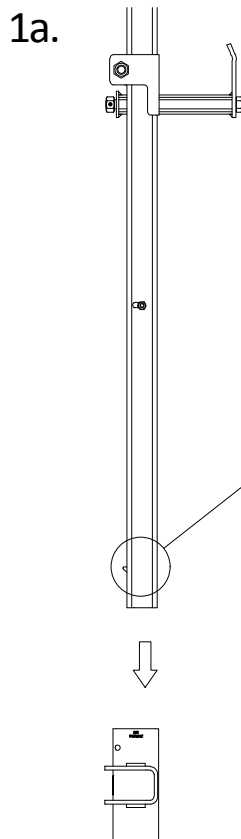
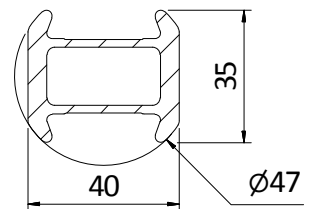

2.

20 Nm

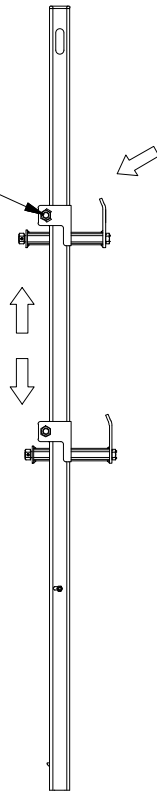
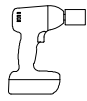

2x



9-720-01-001/
9-720-01-006

3a.

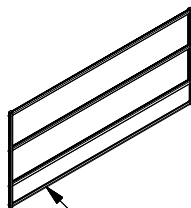

9-720-01-001

20 Nm

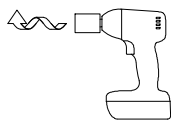

20 Nm

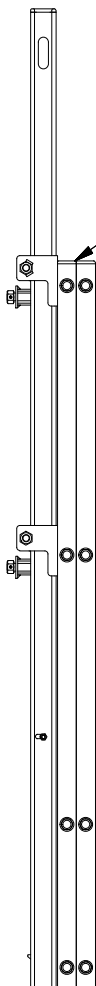
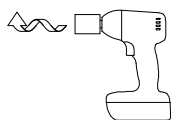

3b.

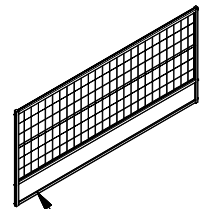

9-720-01-006

20 Nm

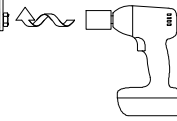

~~20 Nm~~

